

## KNOTEN

### Weberknoten

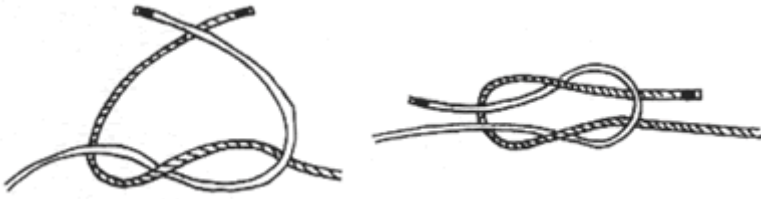

### Gekreutzer Weberknoten



### Zimmermannsklink

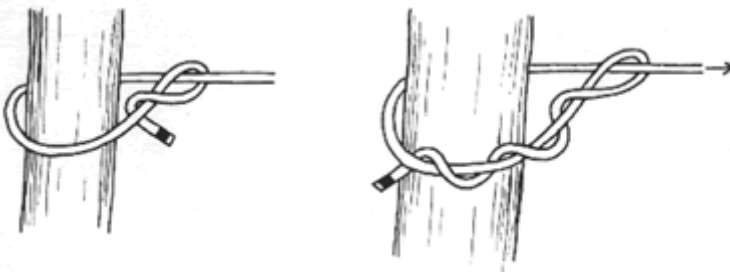

### Achterschlinge (Weberleinstek, Mastwurf)

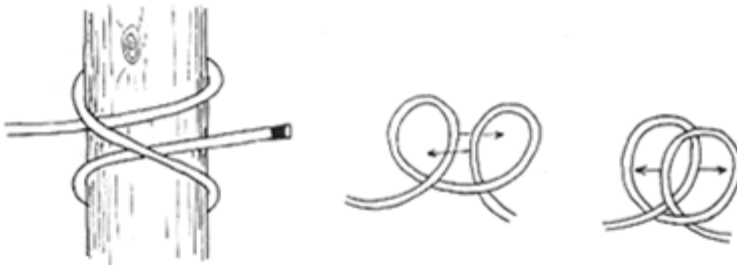

### Rettungsschlinge (Palstek)

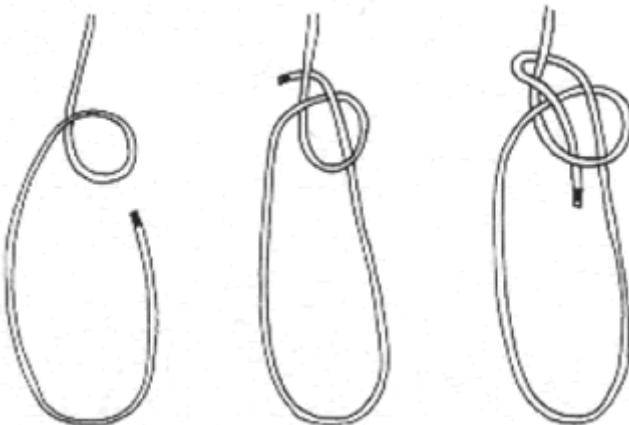

## Prusiknoten

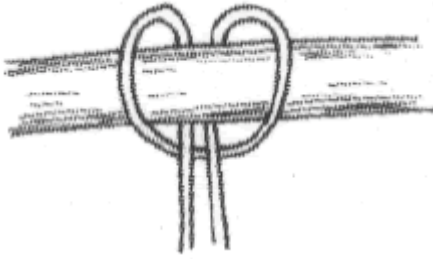

## Gleitschlinge („Schlinge mit Achterschlinge“)

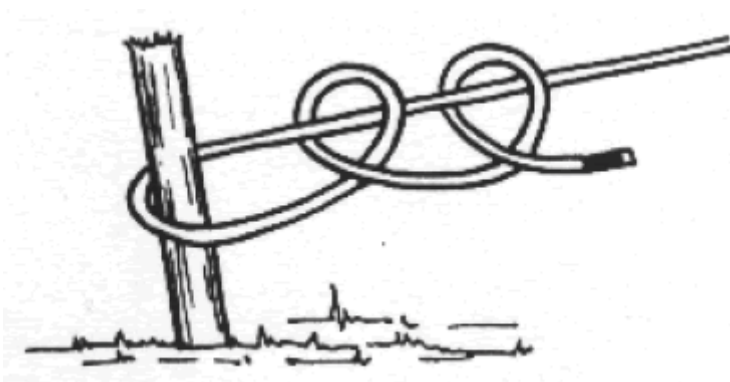

## Fuhrmannsknoten (Seilabspannung)

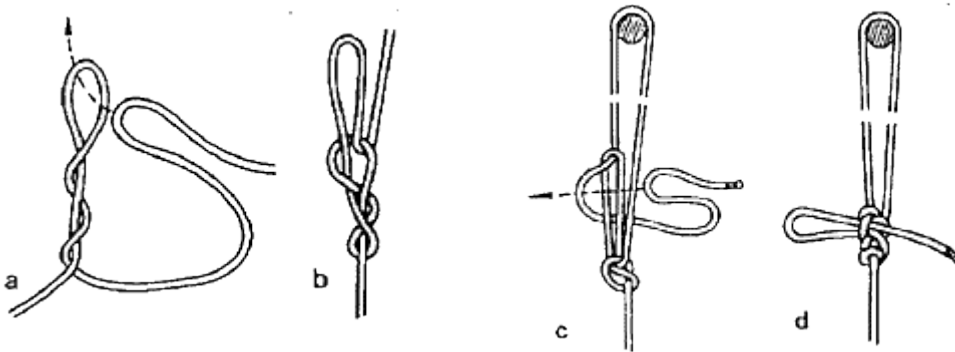

## Fischerknoten (Spirnstich)

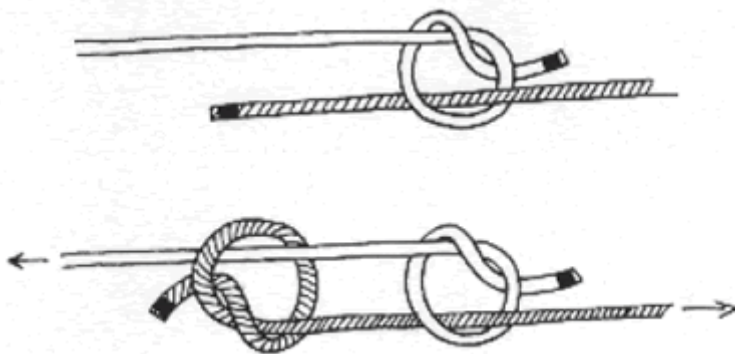

**BÜNDE**

**Kreuzbund**

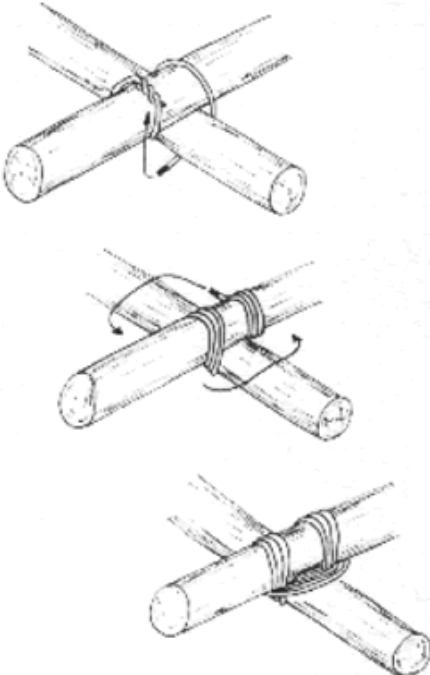

**Diagonalbund**

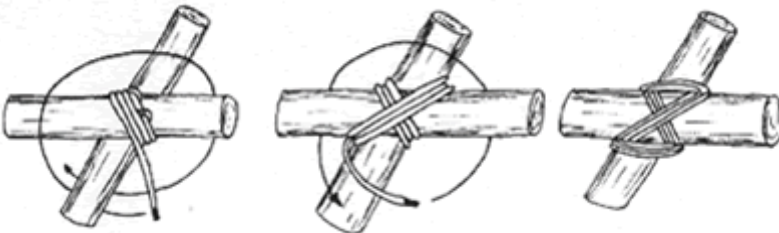

**Längsbund**



**Dreibeinbund (Dreibund)**

